



A company of SIM Tech

# MT3333/MT3339 PLATFORM

## FIRMWARE UPDATE

## PROCEDURE

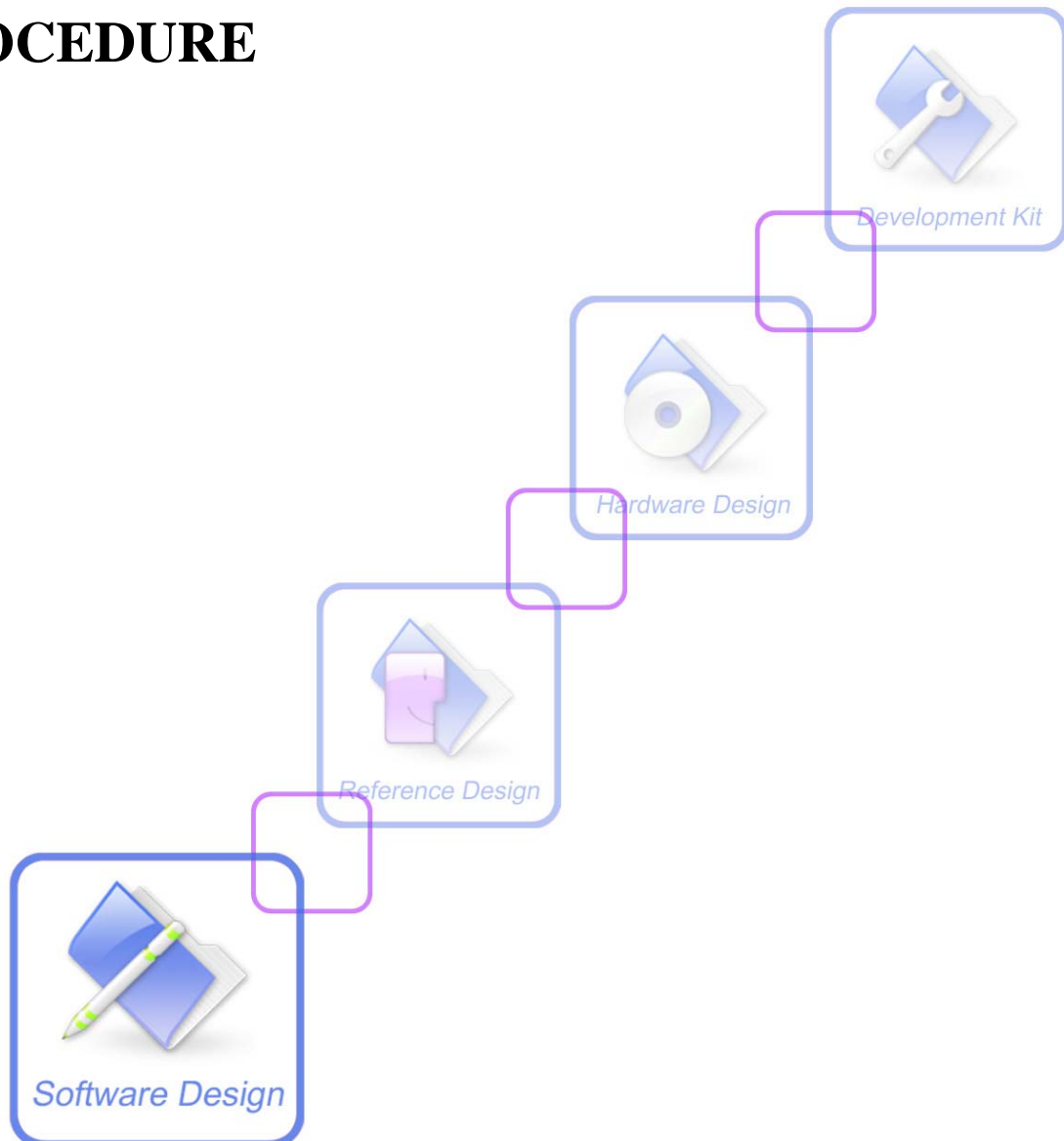

<b>Document Title:</b>	MT3333/MT3339 Platform Firmware Update Procedure
<b>Version:</b>	V1.00
<b>Date:</b>	2013-09-17
<b>Status:</b>	Release
<b>Document Control ID:</b>	MT3333/MT3339_Platform_Firmware Update Procedure_V1.00

## General Notes

SIMCOM offers this information as a service to its customers, to support application and engineering efforts that use the products designed by SIMCOM. The information provided is based upon requirements specifically provided to SIMCOM by the customers. SIMCOM has not undertaken any independent search for additional relevant information, including any information that may be in the customer's possession. Furthermore, system validation of this product designed by SIMCOM within a larger electronic system remains the responsibility of the customer or the customer's system integrator. All specifications supplied herein are subject to change.

## Copyright

This document contains proprietary technical information which is the property of Shanghai SIMCom Wireless Solutions Ltd, copying of this document and giving it to others and the using or communication of the contents thereof, are forbidden without express authority. Offenders are liable to the payment of damages. All rights reserved in the event of grant of a patent or the registration of a utility model or design. All specification supplied herein are subject to change without notice at any time.

*Copyright © Shanghai SIMCom Wireless Solutions Ltd. 2013*

## Version History

Version	Chapter	What is new
V1.00	Original version	Original

# Contents

<b>VERSION HISTORY</b> .....	<b>3</b>
<b>1 INTRODUCTION</b> .....	<b>6</b>
1.1 SCOPE OF THE DOCUMENT .....	6
1.2 RELATED DOCUMENTS .....	6
1.3 TERM ABBREVIATION .....	6
<b>2 PROCEDURE</b> .....	<b>6</b>
2.1 CMD_START .....	7
2.2 CMD_WRITE .....	8
2.3 CMD_JUMP.....	9
2.4 CMD_SYNC .....	9
2.5 CMD_SETMEMBLOCK.....	10
2.6 CMD_WRITE DATA.....	11
2.7 CMD_FINISH.....	12

## Tables

Table 1-1: Term abbreviation.....	6
Table 2-1: firmware update procedure.....	7

## Figures

Figure 1-1: firmware update connection.....	6
Figure 2-1: CMD_start.....	7
Figure 2-2: CMD_write .....	8
Figure 2-3: CMD_Jump.....	9
Figure 2-4: CMD_Sync .....	10
Figure 2-5: CMD_SetMemBlock .....	11
Figure 2-6: CMD_WriteData .....	11
Figure 2-7: CMD_Finish .....	12

# 1 Introduction

## 1.1 Scope of the document

This document presents details of Boot ROM handshaking and flash download/format.

This update procedure support MT3339 platform modules, including: SIM28, SIM28C, SIM39EA and SIM928A. And support MT3333 platform modules also, including: SIM68R, SIM68V, SIM968 .

Following this procedure, user can download built image to target side via RS232.

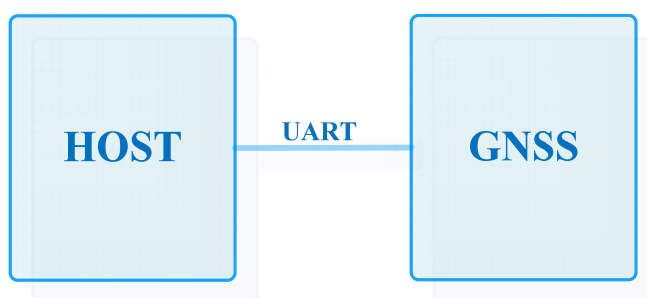

Figure 1-1: firmware update connection

## 1.2 Related documents

- (1) 《MT3333 Platform NMEA Message Specification For GPS+GLONASS\_V1.00》
- (2) 《MT3339 Platform NMEA Message Specification\_V1.00》

## 1.3 Term abbreviation

Table 1-1: Term abbreviation

Term	Definition
DA	Download Agent
BROM	Boot ROM
SRAM	Static random-access memory
ACK	Acknowledge
NACK	Negative Acknowledge

# 2 Procedure

The whole procedure has two stages:

Stage I:

Download DA to Internal SRAM, and then jump to DA Start Address to execute DA in Internal SRAM.

Stage II:

Download BIN file to flash, then jump to flash Start Address to execute program..

Table 2-1: firmware update procedure

Stage	Step	Command	Description
I	1	CMD_Start	Send update start commands
	2	CMD_Write	write DA file to SRAM
	3	CMD_Jump	Jump to DA start address and execute
II	4	CMD_Sync	Sync and report flash information
	5	CMD_SetMemBlock	Set memory block information
	6	CMD_WriteData	Write BIN file to flash
	7	CMD_Finish	Notify DA to power off target

### 2.1 CMD\_Start

After GNSS module is power on. Send NMEA\_START\_CMD "\$PMTK180\*3B\r\n" to GNSS to start update procedure.

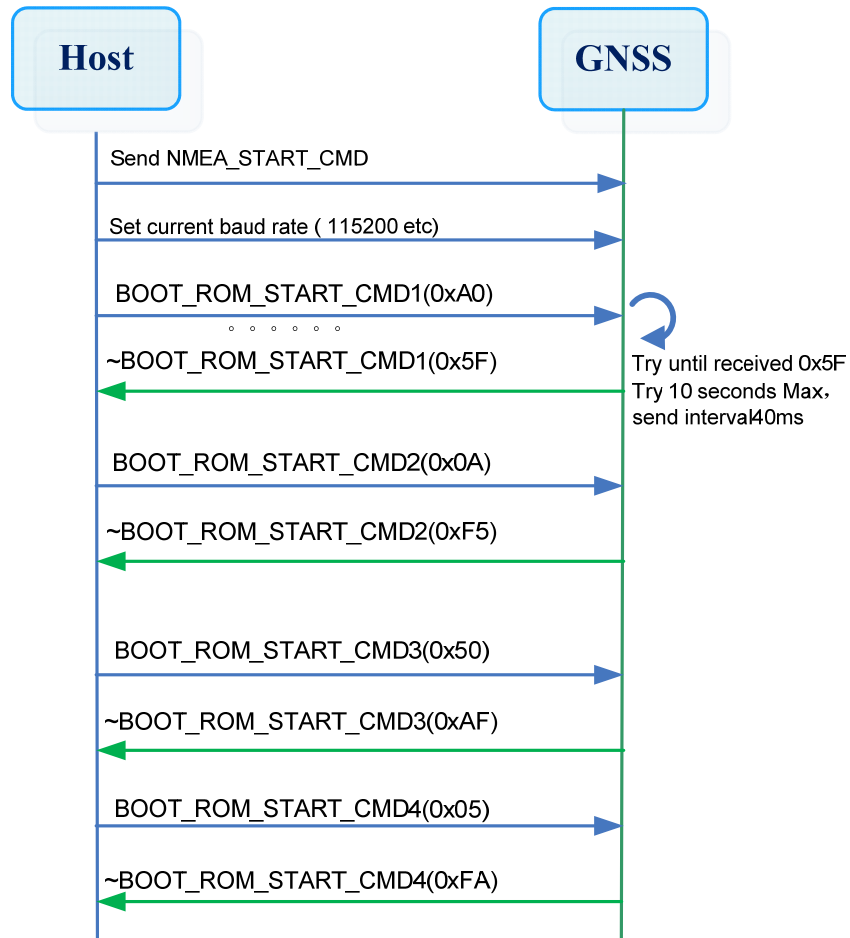

Figure 2-1: CMD\_start

## 2.2 CMD\_Write

This command will write DA file to SRAM.

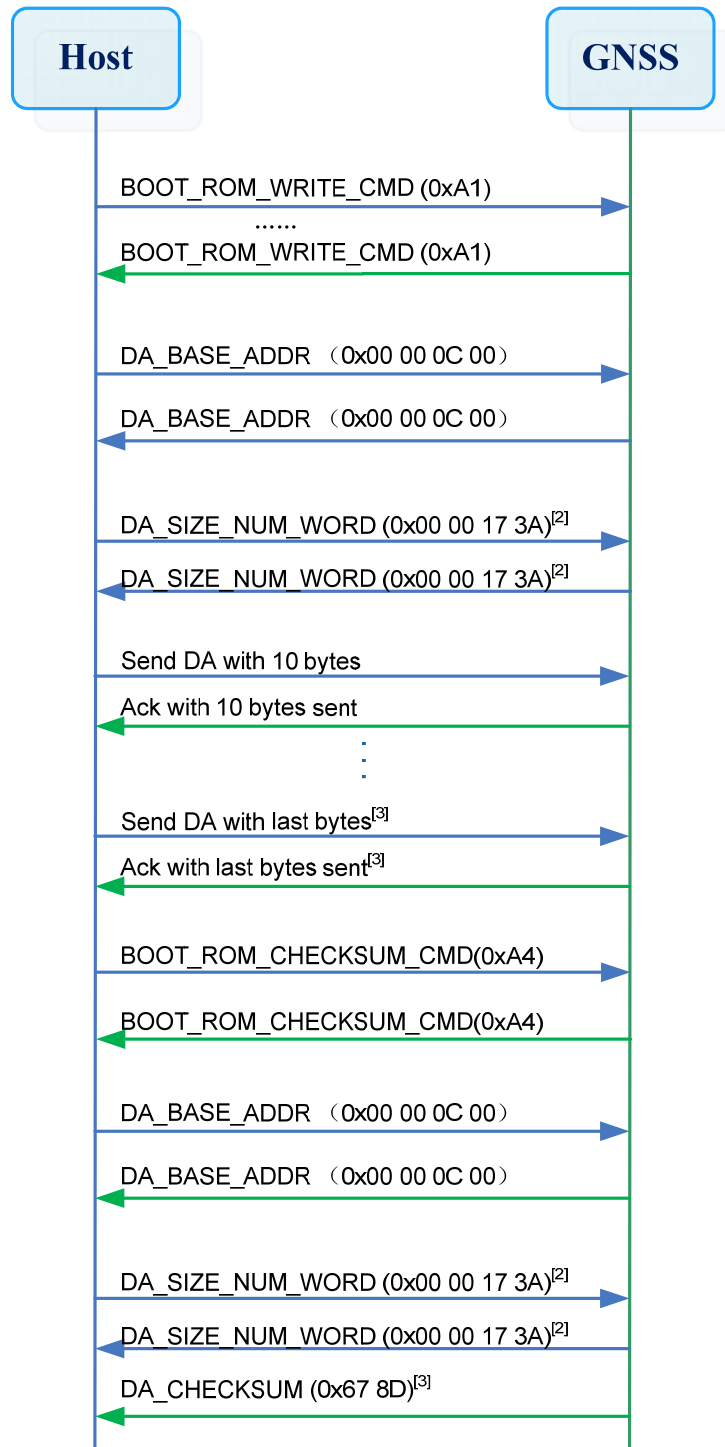

Figure 2-2: CMD\_write



## 2.3 CMD\_Jump

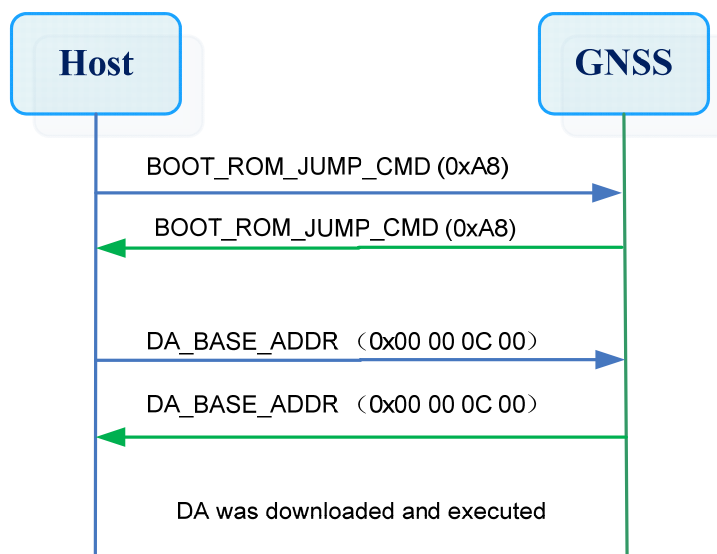

Figure 2-3: CMD\_Jump

## 2.4 CMD\_Sync

When DA was downloaded and executed, it will actively report one byte **SYNC\_CHAR**, two bytes **DA\_VERSION**, one byte **FLASH\_DEVICE\_ID**, four bytes **FLASH\_SIZE**, eight bytes **FLASH\_HW\_ID** and four bytes **EXT\_SRAM\_SIZE**.

- **SYNC\_CHAR:**

When DA was executed, it will return **SYNC\_CHAR** (0xC0). If the return byte isn't **SYNC\_CHAR**, which means it's possibly downloading a wrong DA.

- **DA\_VERSION:**

After **SYNC\_CHAR**, DA will return DA's version number, it contains two bytes, one is major version, and the other is minor version. Program should check whether if it supports this DA.

- **FLASH\_DEVICE\_ID:**

After report the DA version, DA will automatically detect the flash type on target.

- **FLASH\_SIZE:**

Four bytes flash size, for example: 128Mbits flash will be 0x01000000 bytes; DA will send 0x01, 0x00, 0x00, and 0x00.

- **FLASH\_MANUFACTURE\_CODE:**

Two bytes flash manufacture code. (Users should refer to the datasheet for each flash.)

- **FLASH\_DEVICE\_CODE:**

Two bytes flash device code. (Users should refer to the datasheet for each flash.)

- **FLASH\_EXT\_DEVICE\_CODE1:**

Two bytes flash extended device code1. (Users should refer to the datasheet for each flash.)

- **FLASH\_EXT\_DEVICE\_CODE2:**

Two bytes flash extended device code2. (Users should refer to the datasheet for each flash.)

- **EXT\_SRAM\_SIZE:**

Four bytes external SRAM size, for example: 64Mbits external SRAM will be 0x00800000 bytes; DA will send 0x00, 0x80, 0x00, and 0x00.

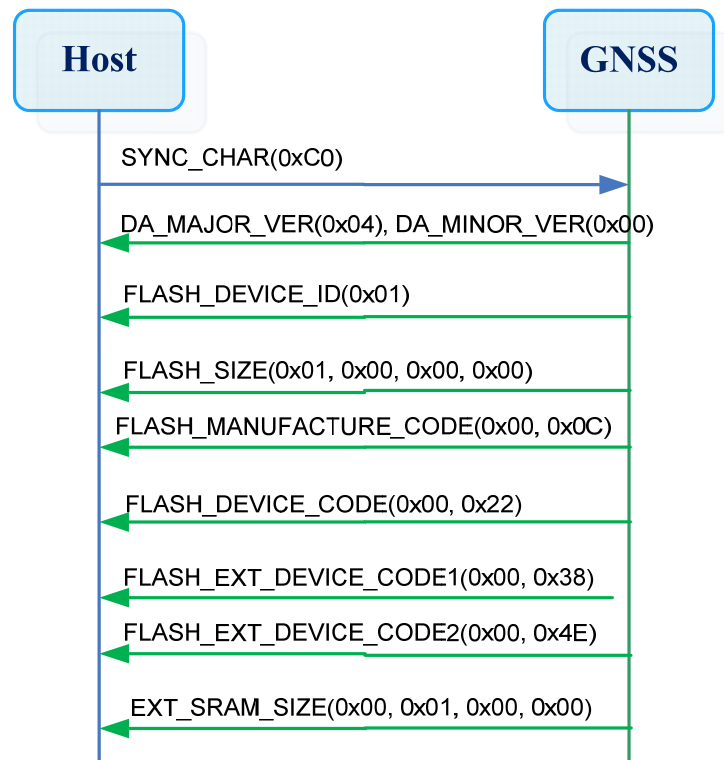

Figure 2-4: CMD\_Sync

**Note:**

1. The Flash related information are fixed for handshake authorization, not real flash information.

## 2.5 CMD\_SetMemBlock

This command is used to notify DA the total memory block count and the range for each block. The block information indicates how many BIN files will be downloaded and the range of each BIN file. If any memory block exceeds the flash size, DA will return NACK (0xA5) to indicate the **DA\_MEM\_CMD** command is fail. If all the download memory blocks are valid, DA will return ACK (0x5A) and **UNCHANGED\_BLOCK\_COUNT** to notify PC side how many unchanged block should be recovery after downloading.

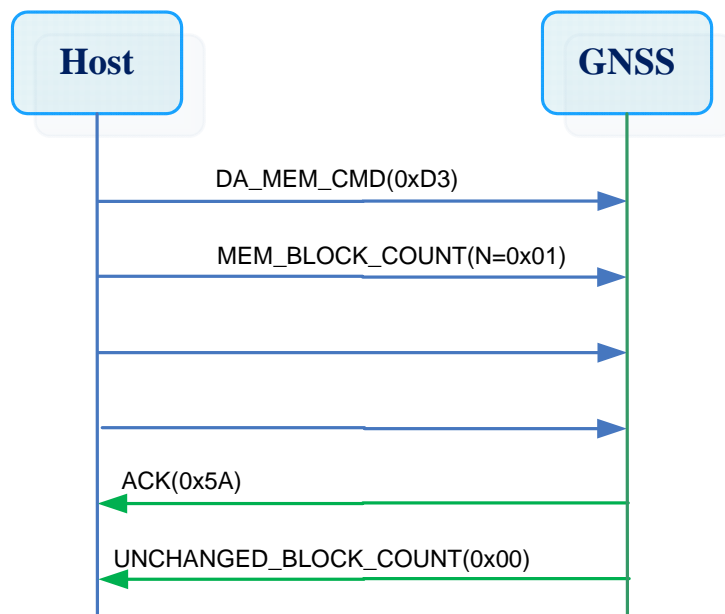

Figure 2-5: CMD\_SetMemBlock

## 2.6 CMD\_WriteData

This command is used to write all the data of BIN files to target side flash. Every packet is fixed length; that is PACKET\_LENGTH plus two bytes checksum. The last packet is usually not enough for PACKET\_LENGTH, Program should fill 0x00 as padding until reach PACKET\_LENGTH.

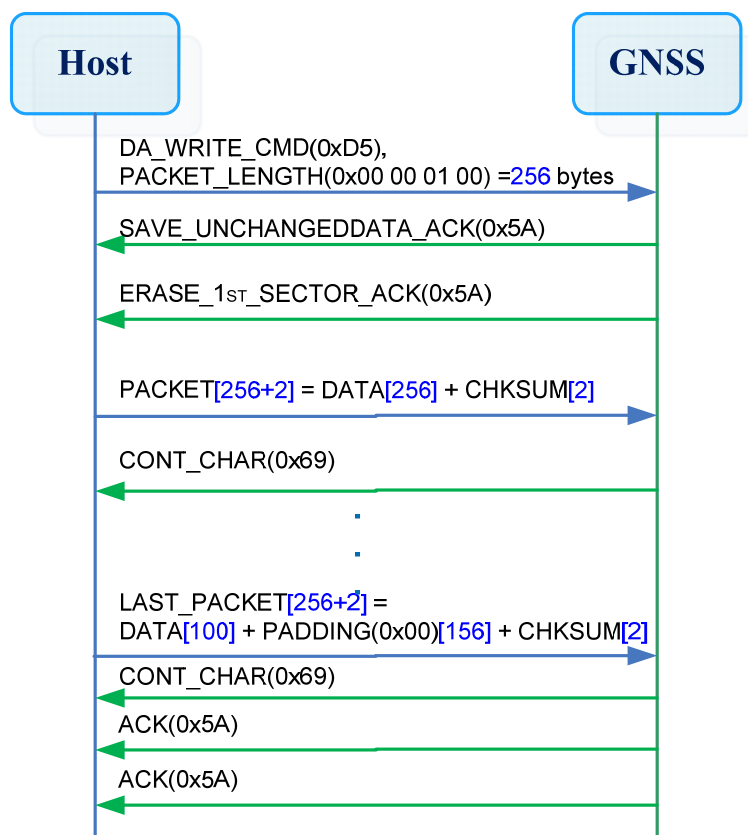

Figure 2-6: CMD\_WriteData

## 2.7 CMD\_Finish

This command is used to notify DA to power off target by unlocks RTC power key. And then GNSS will output NMEA sentences. The firmware update procedure is finished.

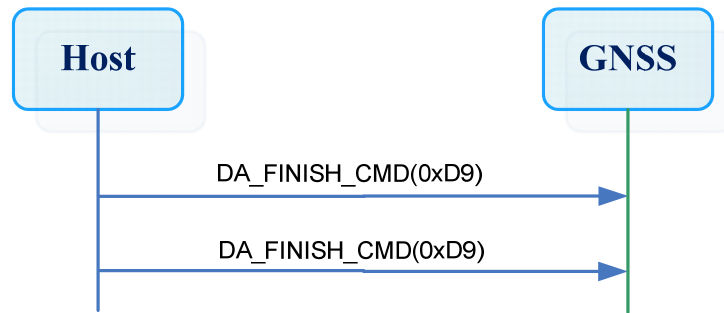

Figure 2-7: CMD\_Finish

**Contact us:**

**Shanghai SIMCom wireless solutions Ltd.**

Address: Building A, SIM Technology Building, No. 633 Jinzhong Road, Shanghai,  
P. R. China 200335

Tel: +86 21 3252 3300

Fax: +86 21 3252 2030

URL: [www.sim.com/wm](http://www.sim.com/wm)